

GP1L57

Wide Gap Type Photointerrupter

■ Features

1. Wide gap between emitter and detector (Gap width : 10 mm)
2. Deep groove type (Depth : 12.2 mm)
3. With positioning pin
4. PWB direct mounting type package

■ Applications

1. Analytical equipment, measuring instruments
2. Amusement equipment
3. Optoelectronic switches, optoelectronic counters

■ Outline Dimensions

(Unit : mm)

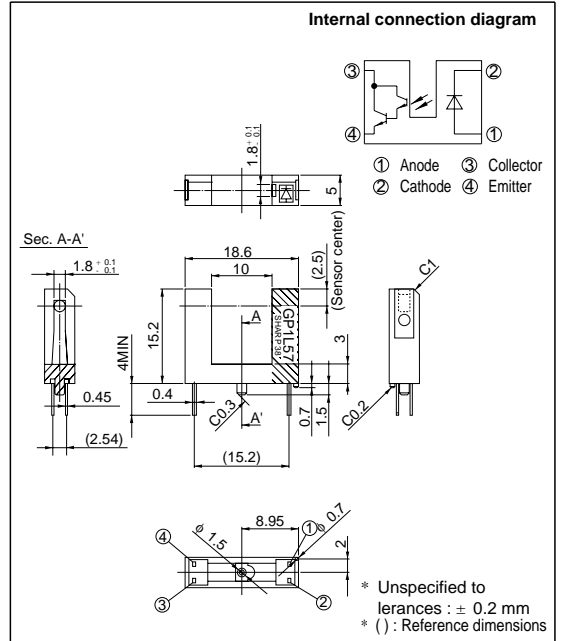

■ Absolute Maximum Ratings

(Ta=25°C)

Parameter		Symbol	Rating	Unit
Input	Forward current	I_F	50	mA
	*1 Peak forward current	I_{FM}	1	A
	Reverse voltage	V_R	6	V
	Power dissipation	P	75	mW
Output	Collector-emitter voltage	V_{CEO}	35	V
	Emitter-collector voltage	V_{ECO}	6	V
	Collector current	I_C	40	mA
	Collector power dissipation	P_C	75	mW
Operating temperature		T_{opr}	- 25 to + 85	°C
Storage temperature		T_{stg}	- 40 to + 100	°C
*2 Soldering temperature		T_{sol}	260	°C

*1 Pulse width $\leq 100\mu$ s, Duty ratio=0.01

*2 For 5 seconds

■ Electro-optical Characteristics

(Ta=25 °C)

Parameter		Symbol	Conditions	MIN.	TYP.	MAX.	Unit
Input	Forward voltage	V_F	$I_F = 20\text{mA}$	-	1.25	1.4	V
	Peak forward voltage	V_{FM}	$I_{FM} = 0.5\text{A}$	-	3	4	V
	Reverse current	I_R	$V_R = 3\text{V}$	-	-	10	μA
Output	Dark current	I_{CEO}	$V_{CE} = 10\text{V}$	-	-	10^{-6}	A
Transfer characteristics	Collector current	I_C	$I_F = 1\text{mA}, V_{CE} = 2\text{V}$	0.7	-	28	mA
	Collector-emitter saturation voltage	$V_{CE(sat)}$	$I_F = 4\text{mA}, I_C = 0.6\text{mA}$	-	-	1	V
	Response time	Rise time	t_r	$V_{CE} = 2\text{V}, I_C = 2\text{mA}$	-	130	400
Fall time		t_f	$R_L = 100\ \Omega$	-	100	350	μs

Fig. 1 Forward Current vs. Ambient Temperature

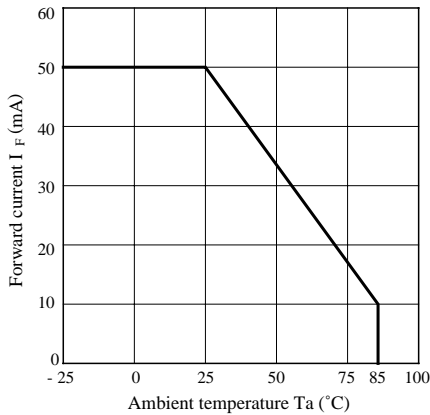

Fig. 2 Collector power Dissipation vs. Ambient Temperature

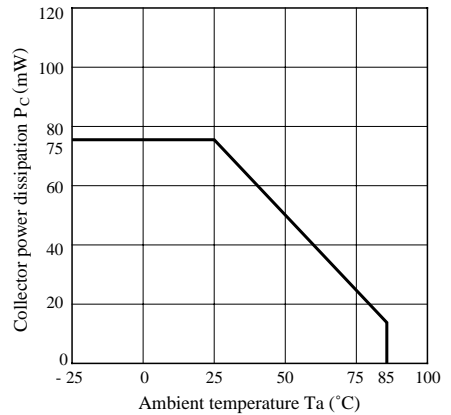

Fig. 3 Peak Forward Current vs. Duty Ratio

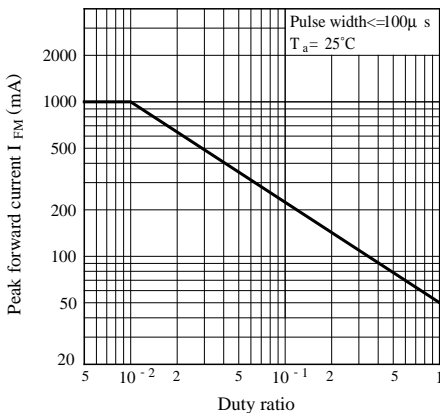

Fig. 4 Forward Current vs. Forward Voltage

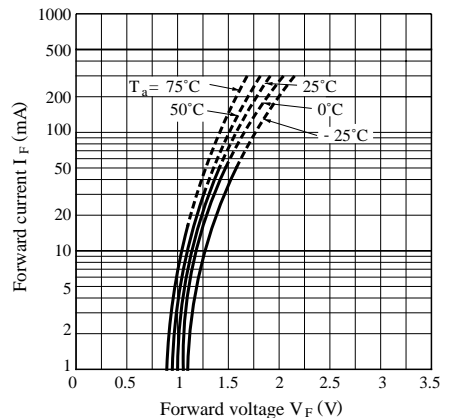

Fig. 5 Collector Current vs. Forward Current

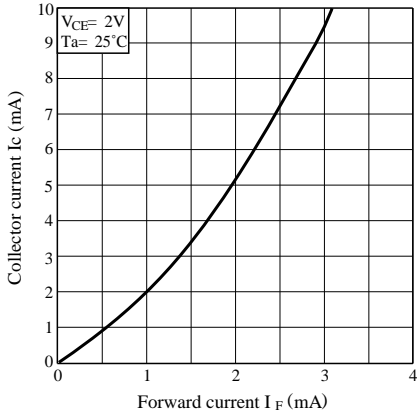

Fig. 6 Collector Current vs. Collector-emitter Voltage

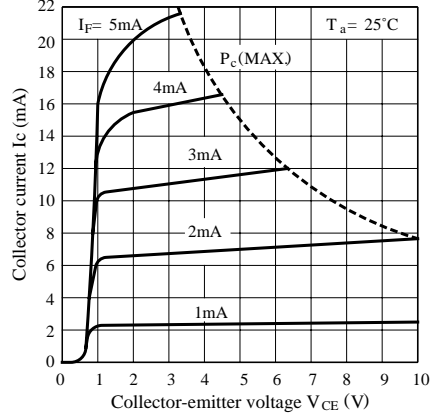

Fig. 7 Collector Current vs. Ambient temperature

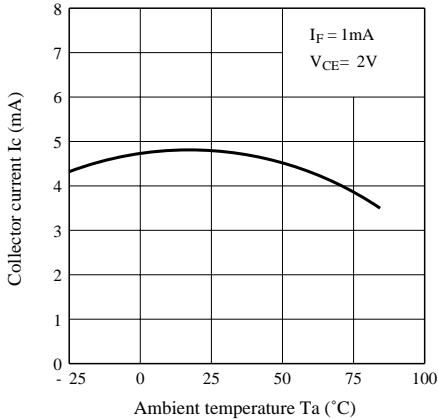

Fig. 8 Collector-emitter Saturation Voltage vs. Ambient Temperature

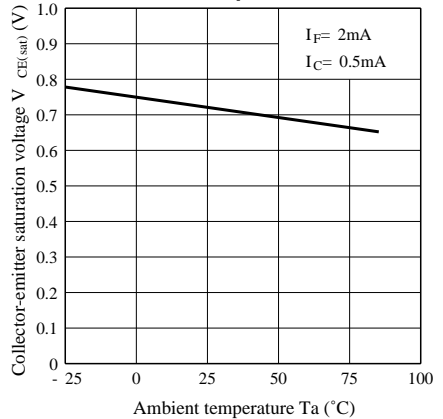
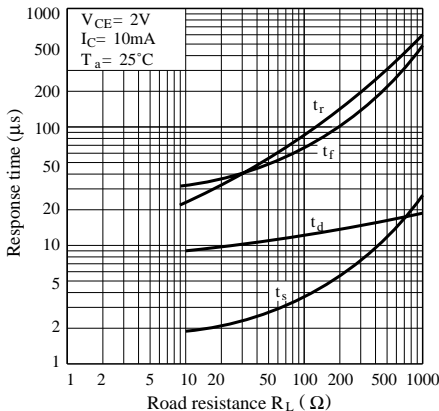

Fig. 9 Response Time vs. Load Resistance



Test Circuit for Response Time

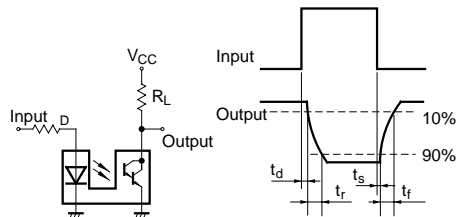

Fig. 10 Frequency characteristics

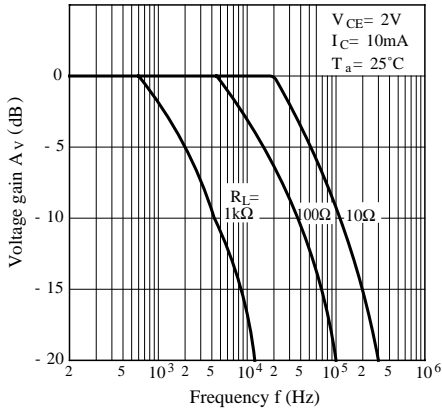

Fig. 11 Dark Current vs. Ambient Temperature

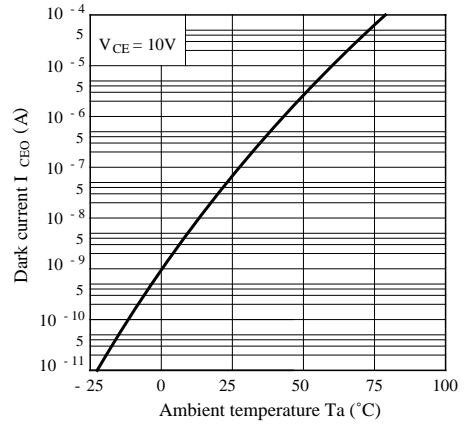

Fig. 12 Detecting Position Characteristics (1)

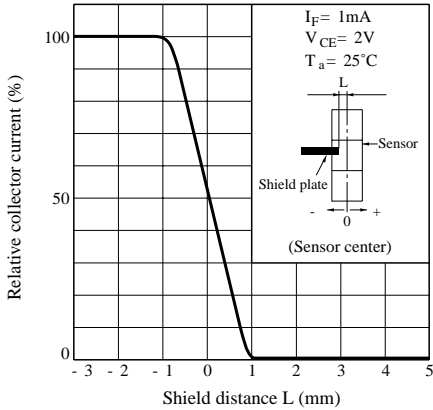
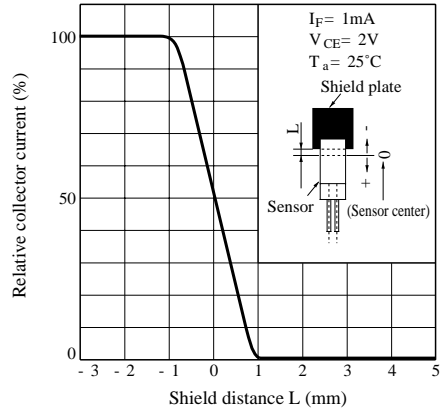

Fig. 13 Detecting Position Characteristics (2)



(Precautions for Operation)

In case of cleaning, use only the following type of cleaning solvent.

Ethyl alcohol, Methyl alcohol, Isopropyl alcohol

- As for other general precautions, please refer to the chapter "Precautions for Use".

NOTICE

- The circuit application examples in this publication are provided to explain representative applications of SHARP devices and are not intended to guarantee any circuit design or license any intellectual property rights. SHARP takes no responsibility for any problems related to any intellectual property right of a third party resulting from the use of SHARP's devices.
- Contact SHARP in order to obtain the latest device specification sheets before using any SHARP device. SHARP reserves the right to make changes in the specifications, characteristics, data, materials, structure, and other contents described herein at any time without notice in order to improve design or reliability. Manufacturing locations are also subject to change without notice.
- Observe the following points when using any devices in this publication. SHARP takes no responsibility for damage caused by improper use of the devices which does not meet the conditions and absolute maximum ratings to be used specified in the relevant specification sheet nor meet the following conditions:
 - (i) The devices in this publication are designed for use in general electronic equipment designs such as:
 - Personal computers
 - Office automation equipment
 - Telecommunication equipment [terminal]
 - Test and measurement equipment
 - Industrial control
 - Audio visual equipment
 - Consumer electronics
 - (ii) Measures such as fail-safe function and redundant design should be taken to ensure reliability and safety when SHARP devices are used for or in connection with equipment that requires higher reliability such as:
 - Transportation control and safety equipment (i.e., aircraft, trains, automobiles, etc.)
 - Traffic signals
 - Gas leakage sensor breakers
 - Alarm equipment
 - Various safety devices, etc.
 - (iii) SHARP devices shall not be used for or in connection with equipment that requires an extremely high level of reliability and safety such as:
 - Space applications
 - Telecommunication equipment [trunk lines]
 - Nuclear power control equipment
 - Medical and other life support equipment (e.g., scuba).
- Contact a SHARP representative in advance when intending to use SHARP devices for any "specific" applications other than those recommended by SHARP or when it is unclear which category mentioned above controls the intended use.
- If the SHARP devices listed in this publication fall within the scope of strategic products described in the Foreign Exchange and Foreign Trade Control Law of Japan, it is necessary to obtain approval to export such SHARP devices.
- This publication is the proprietary product of SHARP and is copyrighted, with all rights reserved. Under the copyright laws, no part of this publication may be reproduced or transmitted in any form or by any means, electronic or mechanical, for any purpose, in whole or in part, without the express written permission of SHARP. Express written permission is also required before any use of this publication may be made by a third party.
- Contact and consult with a SHARP representative if there are any questions about the contents of this publication.